



Lynton

Healthcare Chair

A chair which can easily be adapted for one or multiple users – a ideal standard supply community chair, with quality, style and functionality at the forefront of its design.

Suitable For:

The Lynton has been specifically designed to assist Equipment store providers, Local authorities, Care Home and Distributors to maximise budgets to stretch further.



Fabric in image: ILIV Compass Silver outer
Dartex Vp Grey in contact areas

Specifications:

The Lynton chair has two weight limit of 127 Kg (20 stone) as standard on the small model. The medium and large are available as maximum user weights of 127kg (20 stone) and 159 Kg (25 stone).

The maximum leg rest weight limit is 57 Kg (9 stone) on all models.

	Small	Small (Back Bracket Set 2)	Medium	Medium (Back Bracket Set 2)	Large	Large (Back Bracket Set 2)
Seat Height	16"(406mm)	16"(406mm)	18"(457mm)	18"(457mm)	18"(457mm)	20"(508mm)
Seat Width	18"(457mm)	18"(457mm)	20"(508mm)	20"(508mm)	22"(559mm)	22"(559mm)
Seat Depth	20"(508mm)	18"(457mm)	20"(508mm)	18"(457mm)	20"(508mm)	18"(457mm)
Back Height	28"(711mm)	28"(711mm)	28"(711mm)	28"(711mm)	28"(711mm)	28"(711mm)
Arm Height	7"(178mm)	7"(178mm)	7"(178mm)	7"(178mm)	7"(178mm)	7"(178mm)

Size Alteration

Using a seat depth accessory for further alterations:

- **To reduce the seat depth** 1" Seat depth adjuster 2" seat depth adjuster
- **To increase the seat height** 1" seat height adjuster kit 2" seat height adjuster kit

Repose

Specialist Seating Solutions
a prismhealthcare company

Standard Features:

- Single or Dual tilt in space mechanism
- Interchangeable back cushion options
- Interchangeable pressure management seat cushion options
- Removeable parts for easy of cleaning and servicing
- User friendly size adjustments
- Handset storage
- Heavy duty lockable castors
- Stand aid friendly, using Mackworth TA180 or Freeway Raiser
- Breakdown chair for one man delivery installation

Optional Accessories

- Seat depth adjuster pads
- Seat height adjustment kit
- Pressure management seating options
- Accupak rechargeable battery system with alarm
- Styleline on/off handset
- Various headrest options
- Enclosure skirt
- 20 cycle back up unit
- Replacement wings, arms, arm tops, seat, back and cushions

Delivery Installation

The Lynton has the unique feature which allows for the chair to be completely dismantled.

The breakdown of the chair will ensure that any one piece is no more than 25kg enabling for a one-man delivery process.

Delivery and installation costs can be kept to a minimum.

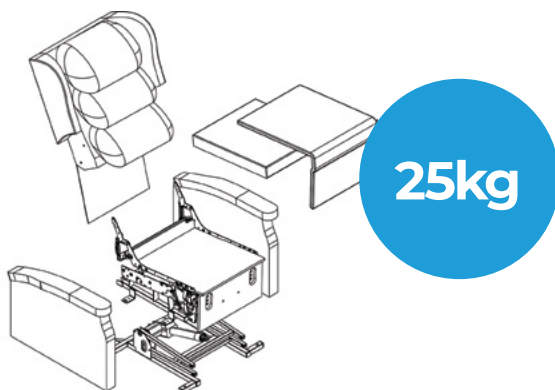

Fabric Options:

The Lynton is shown in ILIV Compass Silver outer with Dartex VP grey inner contact areas.

The ILIV Compass fabrics has all the benefits of being waterproof and antibacterial, as well as steam cleanable.

The Lynton can be manufactured in other colours on contract.

Please note:

Not all fabrics on Reposes portfolio are available.

Mechanism Options:

Dual Tilt In Space

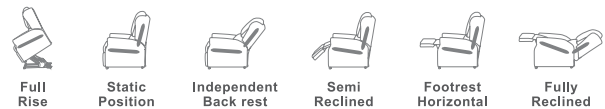

Single Tilt In Space



The Lynton allows for easy service and maintenance even when you find the chair has been accidentally damaged.

The easy to remove arms, arms top and wings allow for you to order replacements and to replace any damaged parts on site to avoid the chair being out of service for long period of time.

- Wings
- Back frame
- Arm tops & Arm frame
- Seat options
- Back posture support cushions
- Mechanism components
- All small accessories